

35-75V Input	12V Output	30A Current	360W Power	2250V dc Isolation	Half-brick DC-DC Converter
------------------------	----------------------	-----------------------	----------------------	------------------------------	--------------------------------------

The BusQor® BQ60120HEX30 Exa series converter is a next-generation, board-mountable, isolated, wide input, regulated, fixed switching frequency DC-DC converter that uses synchronous rectification to achieve extremely high conversion efficiency. The BusQor Exa series provides an isolated step down voltage from 35-75V to 12V with tight output voltage regulation in a standard "half-brick" module and is available in open-frame and baseplated version. BusQor converters are ideal for customers who need multiple outputs and wish to use point of load converters to work with a 12V rail. The BusQor Exa series converters offer industry-leading useable output current for powering intermediate bus architecture systems. RoHS 6/6 compliant (see page last page).

BusQor®

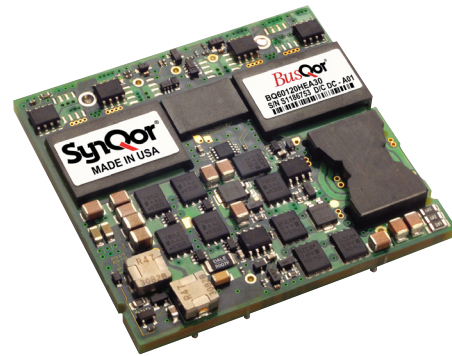

BQ60120HEX30 Model

Operational Features

- Ultra-high efficiency, 95% at full rated load current
- Delivers 30A of current at (360W) full power with minimal derating - no heatsink required
- Wide operating input voltage range: 35-75V with 100V 100ms input voltage transient withstand capability
- Fixed frequency switching provides predictable EMI

Control Features

- On/Off control referenced to input side (positive and negative logic options are available)
- Remote sense for the output voltage compensates for output distribution drops
- Output voltage trim down to 6.0V permits custom voltages and voltage margining (+5%/-50%)
- Short startup inhibit time

Safety Features

- CAN/CSA C22.2 No. 60950-1
- UL 60950-1
- EN 60950-1

Mechanical Features

- Industry standard half-brick pin-out configuration
- Size: 2.4" x 2.3" (61.0x58.4mm), height: 0.422" (10.72mm)
- Total open frame weight: 2.6 oz (75g)

Protection Features

- Input under-voltage lockout
- Output current limit and short circuit protection
- Output over-voltage protection
- Thermal shutdown
- Backdrive protection prevents excessive negative current flow

Contents

Open Frame Mechanical Diagram	2
Baseplated Mechanical Diagram	3
Electrical Characteristics	4
Compliance & Testing	6
Technical Figures	7
Applications Section	11
Ordering Information	14



Open Frame Mechanical Diagram

Input: 35-75V
Output: 12V
Current: 30A
Package: Half-brick

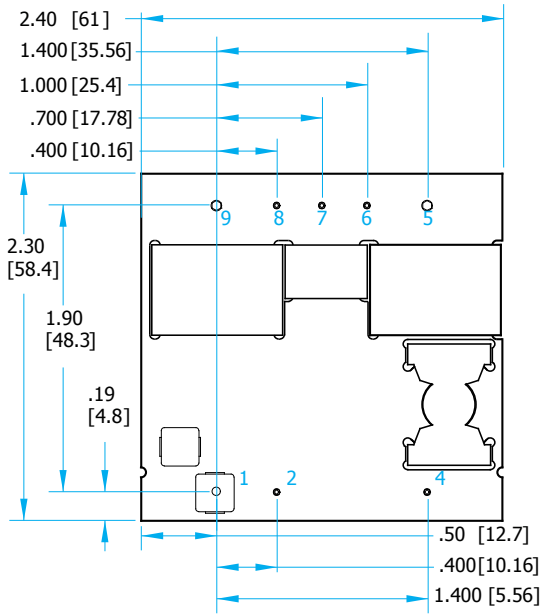

TOP VIEW

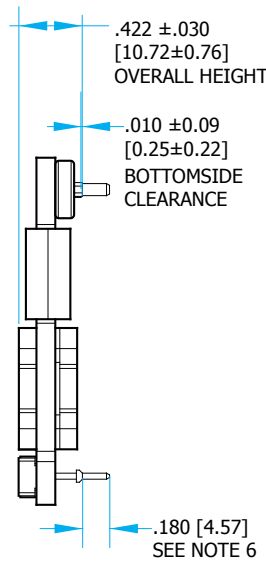

SIDE VIEW

BOTTOM VIEW

EACH EXPOSED COPPER STAPLE CONNECTED TO ADJACENT PIN 5 AND 9 SEE NOTE 7

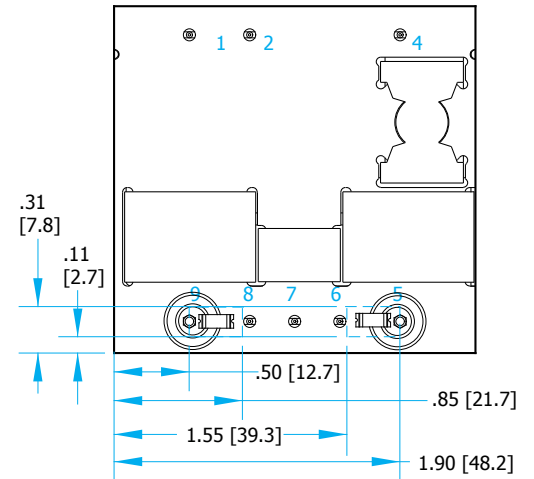

NOTES

- 1) Pins 1, 2, 4, 6-8 are 0.040" (1.02mm) diameter with 0.080" (2.03mm) diameter standoff shoulders
- 2) Pins 5 and 9 are 0.080" (2.03mm) diameter shoulderless pin.
- 3) Other pin extension lengths available
- 4) All pins: Material: Copper Alloy
Finish: Matte Tin over Nickel plate
- 5) Undimensioned components are shown for visual reference only
- 6) Weight: 2.6 oz (75g) typical
- 7) All dimensions in inches (mm)
Tolerances: x.xx in +/-0.02 (x.x mm +/-0.5mm)
x.xxx in +/-0.010 (x.xx mm +/-0.25mm)
- 8) Same net planes recommended on customer board in designated areas adjacent to Pin 5 and 9, as worst case bottom side clearance could cause exposed copper staple to touch customer board surface.
- 9) Workmanship: Meets or exceeds IPC-A-610C Class II

PIN DESIGNATIONS

Pin	Name	Function
1	Vin(+)	Positive input voltage
2	ON/OFF	TTL input to turn converter on and off, referenced to Vin(-), with internal pull up.
4	Vin(-)	Negative input
5	Vout(-)	Negative output
6	Sense(-)	Return remote sense
7	Trim	Output voltage trim
8	Sense(+)	Positive remote sense
9	Vout(+)	Positive output



Baseplated Mechanical Diagram

Input: 35-75V
Output: 12V
Current: 30A
Package: Half-brick

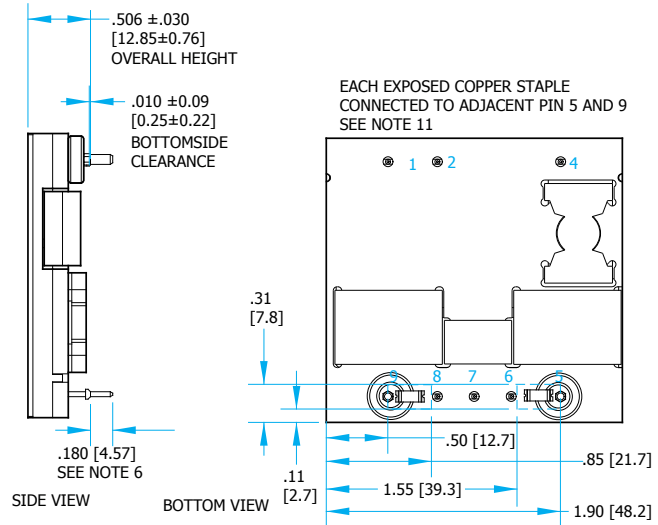
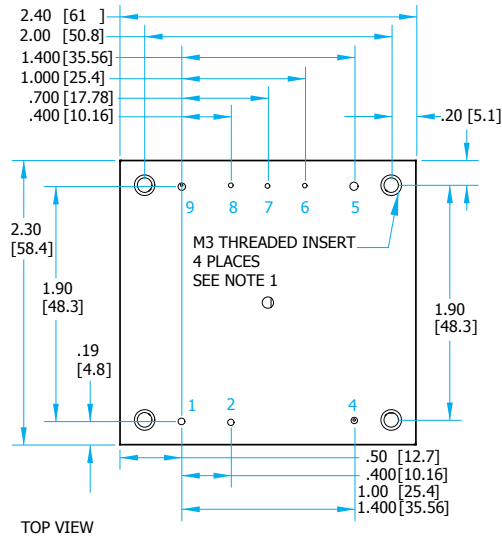

NOTES

- 1) M3 screws used to bolt the unit's baseplate to other surfaces such as heatsinks must not exceed 0.100" (2.54mm) depth below the surface of the baseplate.
- 2) Applied torque per screw should not exceed 6in-lb (0.7Nm).
- 3) Baseplate flatness tolerance is 0.004" (.10mm) TIR for surface
- 4) Pins 1, 2, 4, 6-8 are 0.040" (1.02mm) diameter with 0.080" (2.03mm) diameter standoff shoulders
- 5) Pins 5 and 9 are 0.080" (2.03mm) diameter shoulderless pin.
- 6) Other pin extension lengths available
- 7) All pins: Material: Copper Alloy
Finish: Matte Tin over Nickel plate
- 8) Undimensioned components are shown for visual reference only
- 9) Weight: 3.8 oz (108g) typical
- 10) All dimensions in inches (mm)
Tolerances: x.xx in +/-0.02 (x.x mm +/-0.5mm)
x.xxx in +/-0.010 (x.xx mm +/-0.25mm)
- 11) Same net planes recommended on customer board in designated areas adjacent to Pin 5 and 9, as worst case bottom side clearance could cause exposed copper staple to touch customer board surface.
- 12) Workmanship: Meets or exceeds IPC-A-610C Class II

PIN DESIGNATIONS

Pin	Name	Function
1	Vin(+)	Positive input voltage
2	ON/OFF	TTL input to turn converter on and off, referenced to Vin(-), with internal pull up.
4	Vin(-)	Negative input
5	Vout(-)	Negative output
6	Sense(-)	Return remote sense
7	Trim	Output voltage trim
8	Sense(+)	Positive remote sense
9	Vout(+)	Positive output



Technical Specification

Input: 35-75V
Output: 12V
Current: 30A
Package: Half-brick

BQ60120HEx30 Electrical Characteristics

Ta = 25 °C, airflow rate = 300 LFM, Vin = 48 dc unless otherwise noted; full operating temperature range is -40 °C to +100 °C ambient temperature with appropriate power derating. Specifications subject to change without notice.

Parameter	Min.	Typ.	Max.	Units	Notes & Conditions
ABSOLUTE MAXIMUM RATINGS					
Input Voltage					
Non-Operating	-1		100	V	Continuous
Operating			80	V	Continuous
Operating Transient Protection			100		
Isolation Voltage (Input to Output)			2250	V	
Operating Temperature	-40		100	°C	
Storage Temperature	-45		125	°C	
INPUT CHARACTERISTICS					
Operating Input Voltage Range	35	48	75	V	
Input Under-Voltage Lockout					
Turn-On Voltage Threshold	31.5	33.5	34.4	V	
Turn-Off Voltage Threshold	29.5	30.5	32.4	V	
Lockout Voltage Hysteresis		3.0		V	
Maximum Input Current			11.6	A	100% Load, 35 Vin, trimmed up 5%
No-Load Input Current		140	180	mA	
Disabled Input Current		30	65	mA	
Input Reflected-Ripple Current		20	40	mA	RMS through inductor; Figures 15 & 17
Input Terminal-Ripple Current		130		mA	RMS; Figures 15 & 16
Recommended Input Fuse (see Note 1)			20	A	Fast blow external fuse recommended
Input Filter Component Values (C\L\C)		0\1.0\5.0		µF\µH\µF	Internal values; see Figure D
Output Filter Component Values (Lout\Cout)		100\90		nH\µF	Internal values; see Figure D
Recommended External Input Capacitance	100	100		µF	Typical ESR 0.1-0.2 Ω
Recommended External Input Capacitor ESR	0.04	0.2	1.5	Ω	100kHz, -40°C to 100°C; see note 1
OUTPUT CHARACTERISTICS					
Output Voltage Set Point	11.88	12.00	12.12	V	
Output Voltage Regulation					
Over Line		±0.05\6	±0.1\12	%\mV	
Over Load		±0.1\12	±0.2\24	%\mV	
Over Temperature		±45	±90	mV	
Total Output Voltage Range	11.75		12.33	V	Over sample, line, load, temperature & life
Output Voltage Ripple and Noise					44µF local ceramic, Figures 15 & 18
Peak-to-Peak		60	120	mV	Full Load; Figures 15 & 18
RMS		20	40	mV	Full Load; Figures 15 & 18
Operating Output Current Range	0		30	A	Subject to thermal derating; Figures 7 - 10
Output DC Current-Limit Inception	34	37	40	A	Output Voltage 10% Low; Figure 19
Back-Drive Current Limit while Enabled	0.8	1.8	3.2	A	Negative current drawn from output
Back-Drive Current Limit while Disabled		0.3	0.6	A	Negative current drawn from output
Maximum Output Capacitance			>10,000	µF	12Vout at 30A resistive load
Start-up Output Voltage Overshoot (with max. cap.)		0		%	10,000µF, Iout=30A resistive load
Recommended External Output Capacitance	44			µF	Local ceramic
EFFICIENCY					
100% Load		95		%	
50% Load		95		%	

BQ60120HEx30 Electrical Characteristics (continued)

Ta = 25 °C, airflow rate = 300 LFM, Vin = 48 dc unless otherwise noted; full operating temperature range is -40 °C to +100 °C ambient temperature with appropriate power derating. Specifications subject to change without notice.

Parameter	Min.	Typ.	Max.	Units	Notes & Conditions
FEATURE CHARACTERISTICS					
Switching Frequency Regulation Stage	270	300	330	kHz	
Switching Frequency Isolation Stage	135	150	165	kHz	Synchronous to regulation stage
ON/OFF Control (Option P)					
Off-State Voltage	-2		0.8	V	
On-State Voltage	3.5		18	V	
ON/OFF Control (Option N)					
Off-State Voltage	2.7		18	V	
On-State Voltage	-2		0.8	V	
ON/OFF Control (Either Option)					
Pull-Up Voltage	4.5	5	6	V	Figure A
Pull-Up Resistance		10		kΩ	
Output Voltage Trim Range	-50		+5	%	Measured across Pins 9 & 5; Figure B
Output Over-Voltage Protection	113	118	123	%	Over full temp range; % of nominal Vout
Over-Temperature Shutdown OTP Trip Point		120		%	Average PCB Temperature
Over-Temperature Shutdown Restart Hysteresis		10		°C	
Load Current Scale Factor		600			See App Note: Output Load Current Calc.
DYNAMIC CHARACTERISTICS					
Input Voltage Ripple Rejection		80		dB	120 Hz; Figure 22
Output Voltage during Load Current Transient					
Step Change in Output Current (0.1 A/μs)		300		mV	50% to 75% to 50% Iout max; Figure 13
For a Step Change in Output Current (5A/μs)		500		mV	50% to 75% to 50% Iout max; Figure 14
Settling Time		100		μs	To within 1% Vout nom
Turn-On Transient					
Turn-On Time	8	14	20	ms	Half load, Vout=90% nom.
Start-Up Inhibit Time	2	3	4	ms	-40 °C to +125 °C
TEMPERATURE LIMITS FOR POWER DERATING CURVES					
Semiconductor Junction Temperature			125	°C	Package rated to 150°C
Board Temperature			125	°C	UL rated max operating temp 130°C
Transformer Temperature			125	°C	See Figures 7 - 10 for derating curves
Maximum Baseplate Temperature Limit			100	°C	Applies to BQ60120HEB30 only
ISOLATION CHARACTERISTICS					
Isolation Voltage (dielectric strength)		2250		V	
Isolation Resistance		30		MΩ	
Isolation Capacitance		1000		pF	
RELIABILITY CHARACTERISTICS					
Calculated MTBF (Telcordia) TR-NWT-000332		1.9		10 ⁶ Hrs.	80% load, 300LFM, 40 °C Ta
Calculated MTBF (MIL-217) MIL-HDBK-217F		1.4		10 ⁶ Hrs.	80% load, 300LFM, 40 °C Ta

Note 1: Electrolytic capacitor ESR tends to increase dramatically at low temperature.



Technical Specification

Input: 35-75V
Output: 12V
Current: 30A
Package: Half-brick

Compliance & Testing

Parameter	Notes & Conditions
-----------	--------------------

STANDARDS COMPLIANCE

CAN/CSA C22.2 No. 60950-1

UL 60950-1

EN 60950-1

Note: An external input fuse must always be used to meet these safety requirements. Contact SynQor for official safety certificates on new releases or download from the SynQor website.

Parameter	# Units	Test Conditions
-----------	---------	-----------------

QUALIFICATION TESTING

Life Test	32	95% rated Vin and load, units at derating point, 1000 hours
Vibration	5	10-55 Hz sweep, 0.060" total excursion, 1 min./sweep, 120 sweeps for 3 axis
Mechanical Shock	5	100 g minimum, 2 drops in x, y and z axis
Temperature Cycling	10	-40 °C to 100 °C, unit temp. ramp 15 °C/min., 500 cycles
Power/Thermal Cycling	5	Toperating = min to max, Vin = min to max, full load, 100 cycles
Design Marginality	5	Tmin-10 °C to Tmax+10 °C, 5 °C steps, Vin = min to max, 0-105% load
Humidity	5	85 °C, 85% RH, 1000 hours, continuous Vin applied except 5 min/day
Solderability	15 pins	MIL-STD-883, method 2003

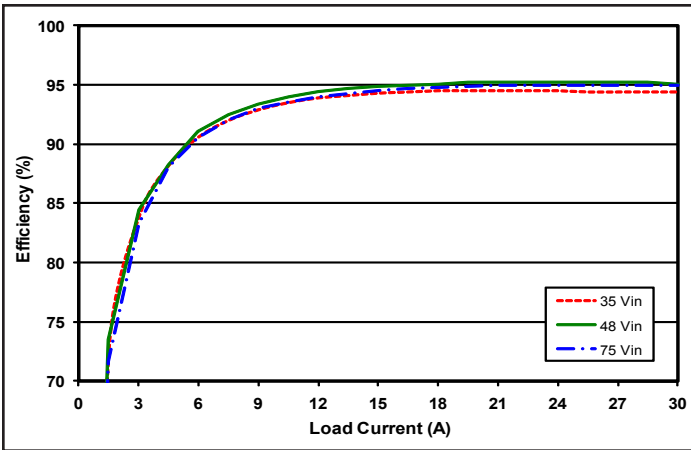

Figure 1: Efficiency at nominal 12V output vs. load current for minimum, nominal, and maximum input voltage at 25°C.

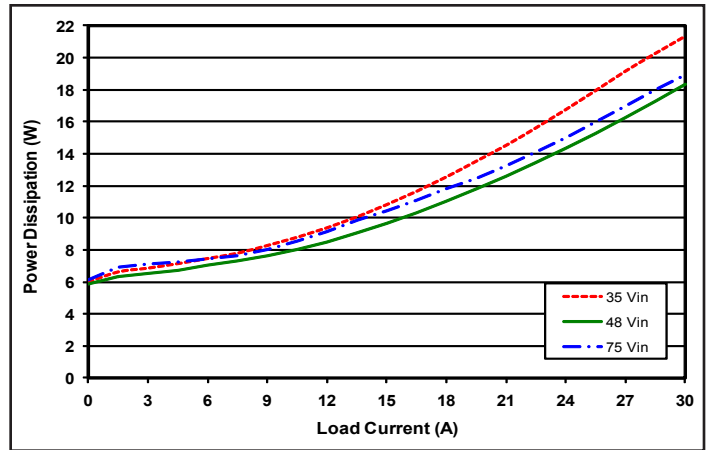

Figure 2: Power dissipation at nominal 12V output vs. load current for minimum, nominal, and maximum input voltage at 25°C.

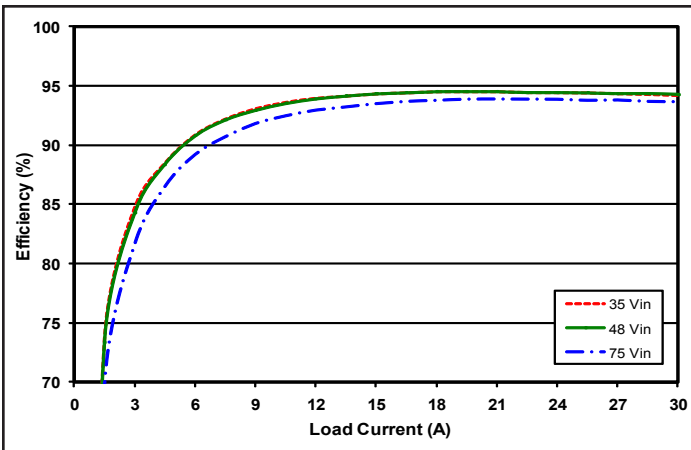

Figure 3: Efficiency at trimmed-down 9.0V output vs. load current for minimum, nominal, and maximum input voltage at 25°C.

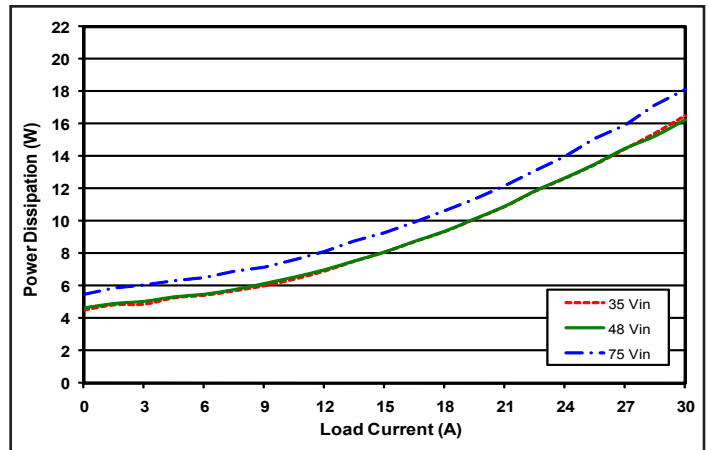

Figure 4: Power dissipation at trimmed-down 9.0V output vs. load current for minimum, nominal, and maximum input voltage at 25°C.

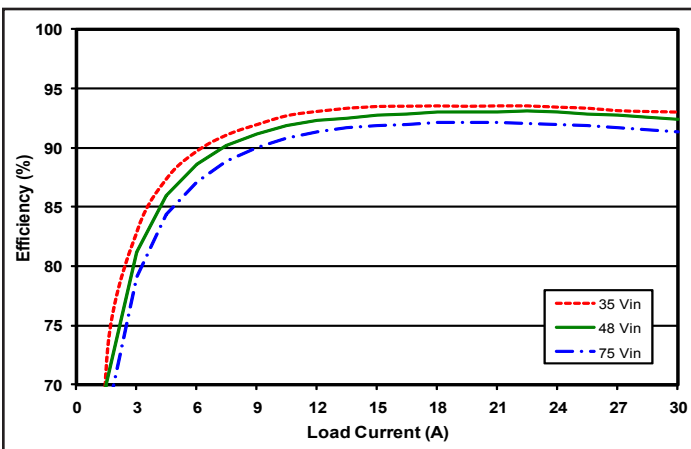

Figure 5: Efficiency at trimmed-down 6.0V output vs. load current for minimum, nominal, and maximum input voltage at 25°C.

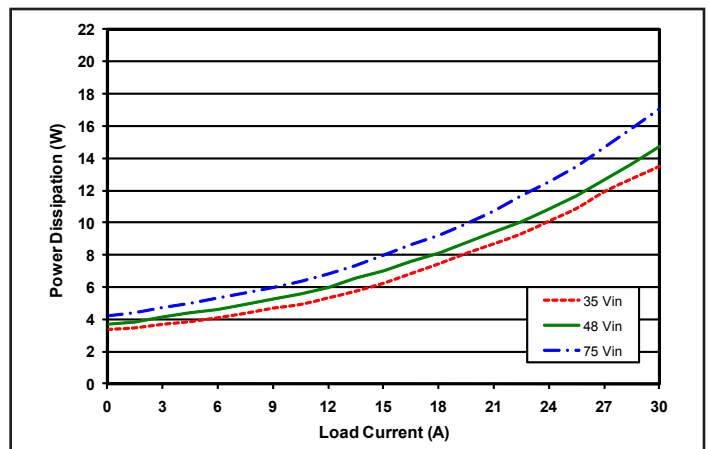

Figure 6: Power dissipation at trimmed-down 6.0V output vs. load current for minimum, nominal, and maximum input voltage at 25°C.

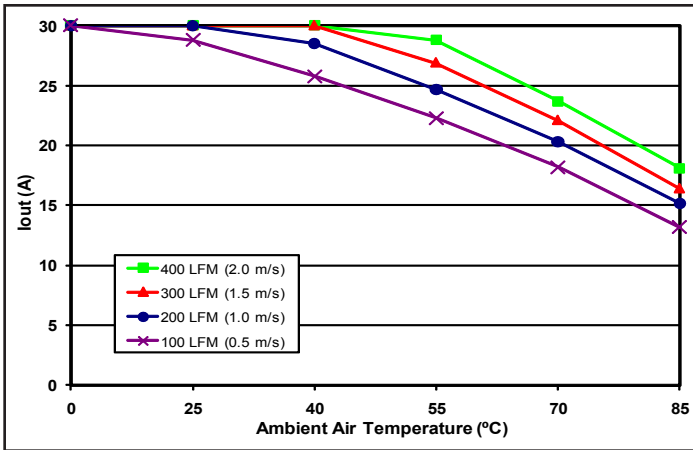

Figure 7: Max output power derating curves vs. ambient air temperature for airflow rates of 100 LFM through 400 LFM with air flowing across the converter from input to output (nominal input voltage).

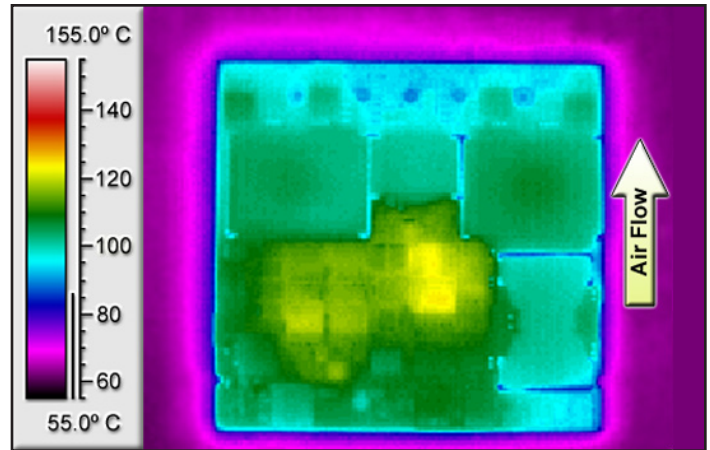

Figure 8: Thermal plot of converter at 25 amp load current (300W) with 55°C air flowing at the rate of 200 LFM. Air is flowing across the converter from input to output (nominal input voltage).

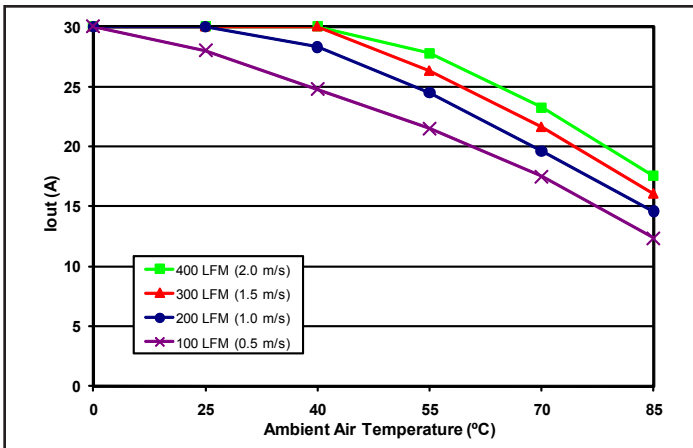

Figure 9: Max output power derating curves vs. ambient air temperature for airflow rates of 100 LFM through 400 LFM with air flowing from pin 1 to pin 4 (nominal input voltage).

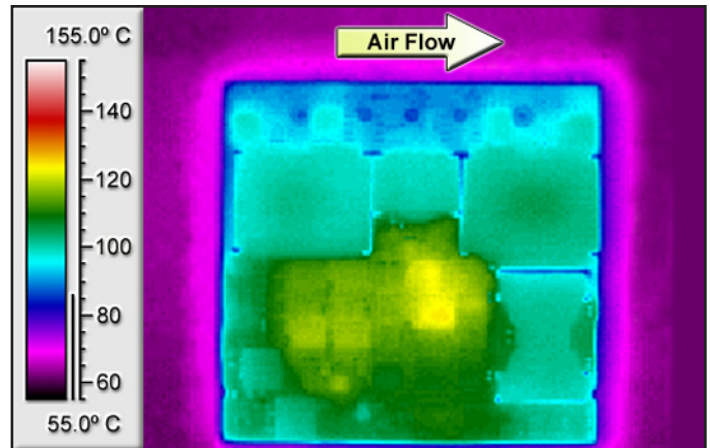

Figure 10: Thermal plot of converter at 24.5 amp load current (294W) with 55°C air flowing at the rate of 200 LFM. Air is flowing across the converter from pin 1 to pin 4 (nominal input voltage).

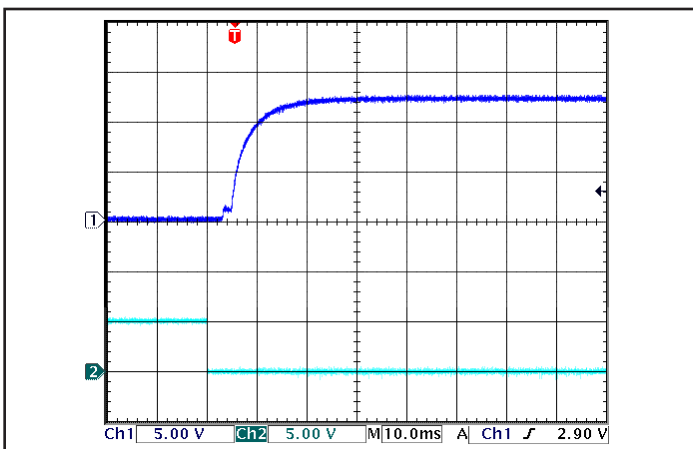

Figure 11: Turn-on transient at full load (resistive load) (10 ms/div). Input voltage pre-applied. Top Trace: V_{out} (5V/div). Bottom Trace: ON/OFF input (5V/div)

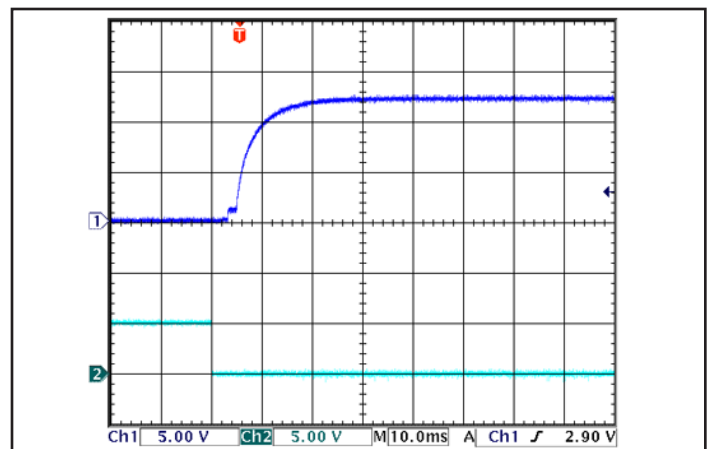

Figure 12: Turn-on transient at zero load (10 ms/div). Top Trace: V_{out} (5V/div). Bottom Trace: ON/OFF input (5V/div).

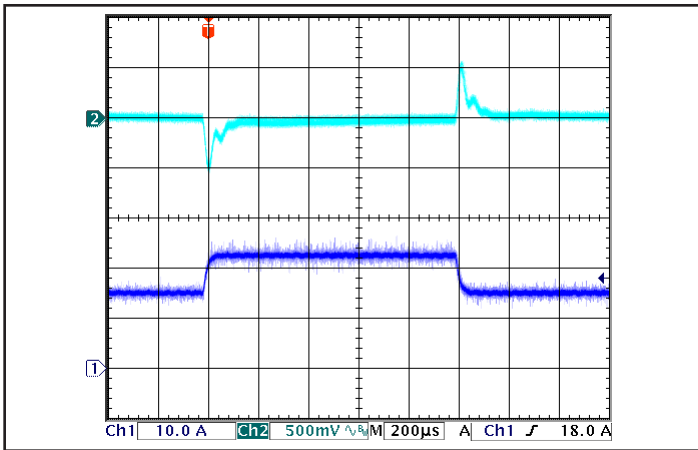

Figure 13: Output voltage response to step-change in load current (50%-75%-50% of $I_{out(max)}$; $dI/dt = 0.1A/\mu s$). Load cap: 47 μF ceramic cap. Top trace: V_{out} (500mV/div), Bottom trace: I_{out} (10A/div).

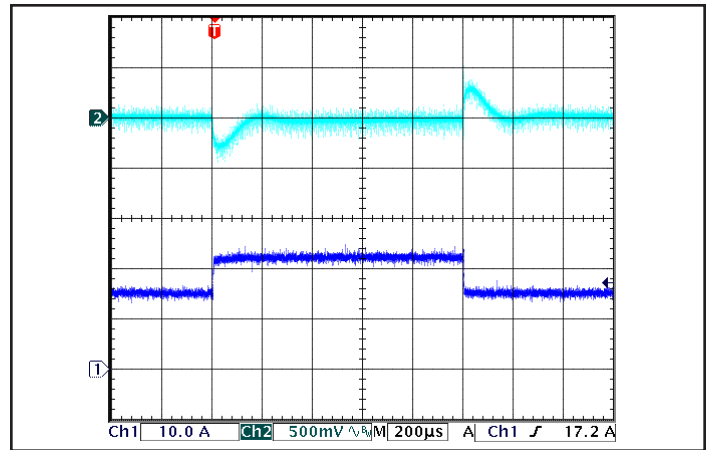

Figure 14: Output voltage response to step-change in load current (50%-75%-50% of $I_{out(max)}$; $dI/dt = 5A/\mu s$). Load cap: 470 μF , 15 m Ω ESR tantalum cap and 47 μF ceramic cap. Top trace: V_{out} (500mV/div), Bottom trace: I_{out} (10A/div).

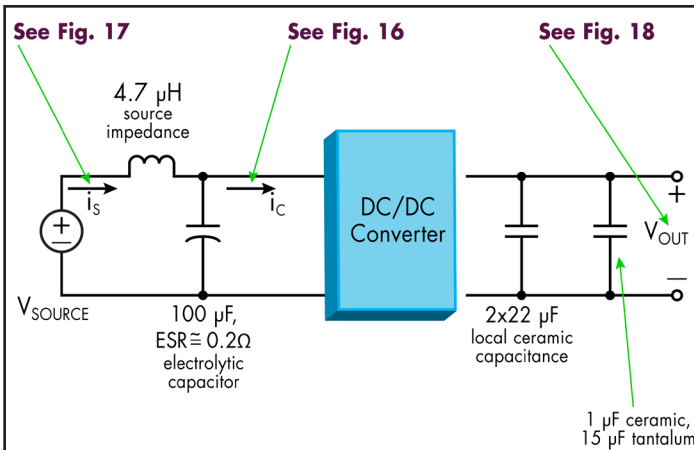

Figure 15: Test set-up diagram showing measurement points for Input Terminal Ripple Current (Fig 16), Input Reflected Ripple Current (Fig 17) and Output Voltage Ripple (Fig 18).

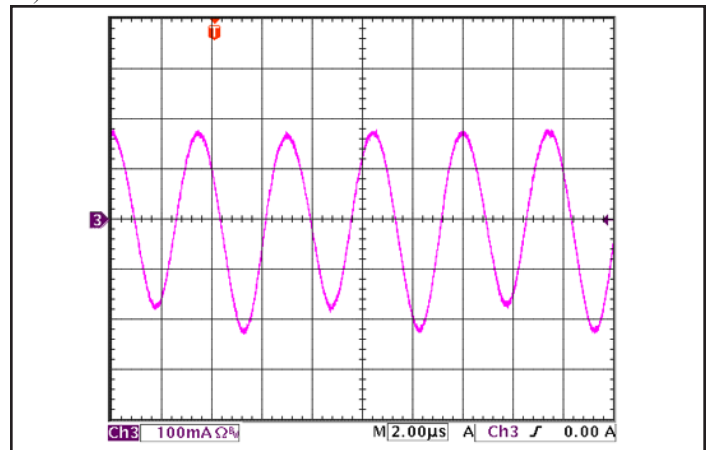

Figure 16: Input terminal ripple current, i_c , at full rated output current and nominal input voltage with 4.7 μH source impedance and 100 μF electrolytic capacitor (100 mA/div). (Fig 15)

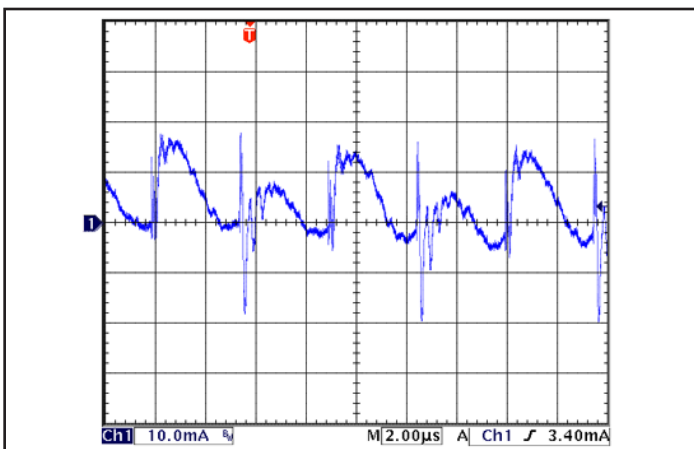

Figure 17: Input reflected ripple current, i_s , through a 4.7 μH source inductor at nominal input voltage and rated load current (10mA/div). (Fig 15)

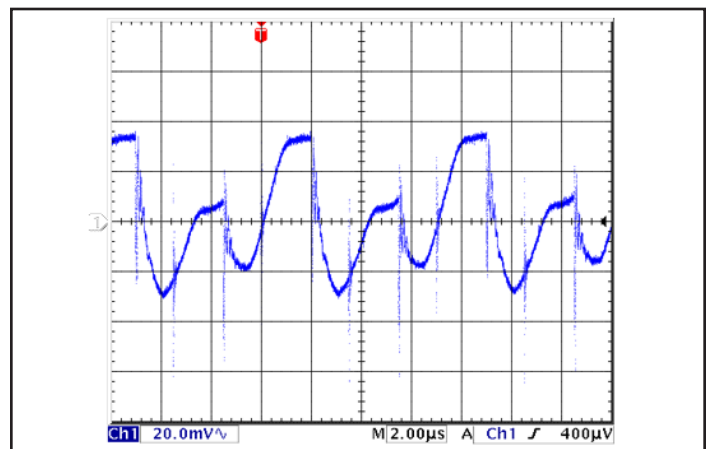

Figure 18: Output voltage ripple at nominal input voltage and rated load current (20mV/div). Load capacitance: 2x22 μF ceramic capacitor. Bandwidth: 500 MHz. (Fig 15)

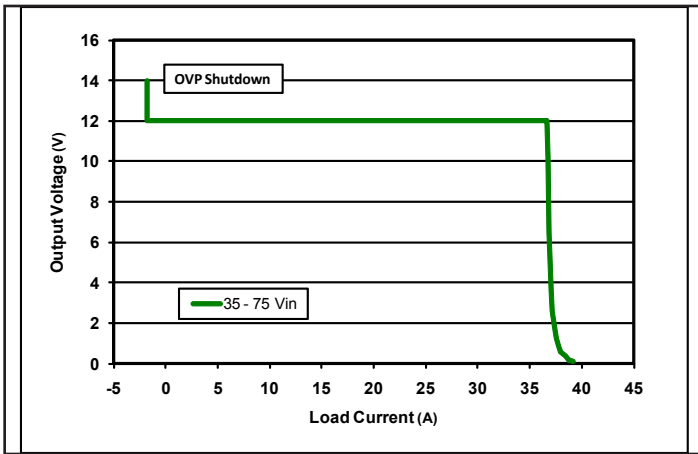

Figure 19: Output voltage vs. load current showing typical current limit curves and OVP shutdown point.

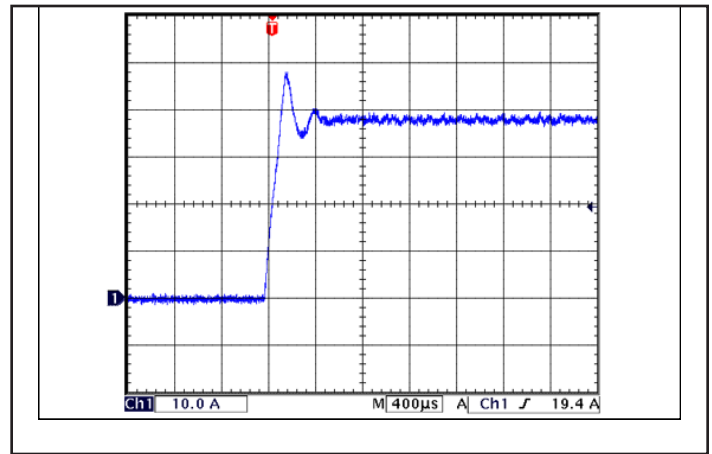

Figure 20: Load current (10A/div) as a function of time when the converter attempts to turn on into a 1mΩ short circuit.

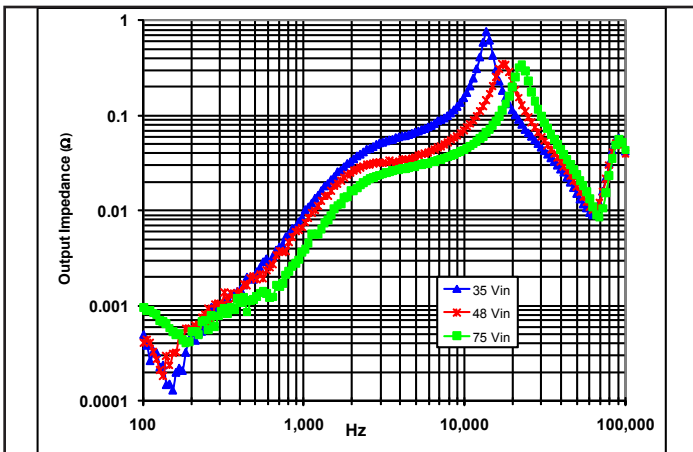

Figure 21: Magnitude of incremental output impedance ($Z_{out} = v_{out}/i_{out}$) for minimum, nominal, and maximum input voltage at full rated power.

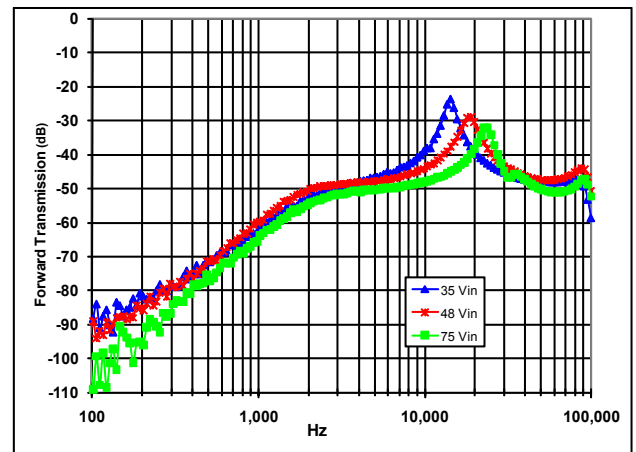

Figure 22: Magnitude of incremental forward transmission ($FT = v_{out}/v_{in}$) for minimum, nominal, and maximum input voltage at full rated power.

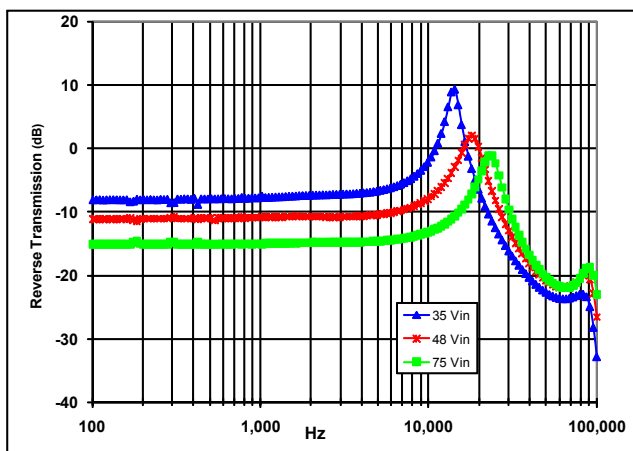

Figure 23: Magnitude of incremental reverse transmission ($RT = i_{in}/i_{out}$) for minimum, nominal, and maximum input voltage at full rated power.

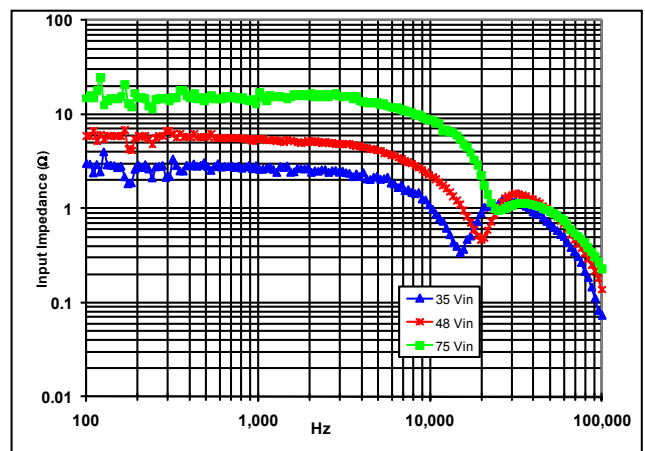

Figure 24: Magnitude of incremental input impedance ($Z_{in} = v_{in}/i_{in}$) for minimum, nominal, and maximum input voltage at full rated power.

BASIC OPERATION AND FEATURES

This converter series uses a two-stage power conversion topology. The first stage keeps the output voltage constant over variations in line, load, and temperature. The second stage uses a transformer to provide the functions of input/output isolation and voltage step-down to achieve the low output voltage required.

Both the first stage and the second stage switch at a fixed frequency for predictable EMI performance. Rectification of the transformer's output is accomplished with synchronous rectifiers. These devices, which are MOSFETs with a very low on-state resistance, dissipate significantly less energy than Schottky diodes, enabling the converter to achieve high efficiency.

Dissipation throughout the converter is so low that it does not require a heatsink for operation in many applications; however, adding a heatsink provides improved thermal derating performance in extreme situations. See Ordering Information page for available thermal design options.

SynQor converters use the industry standard footprint and pin-out.

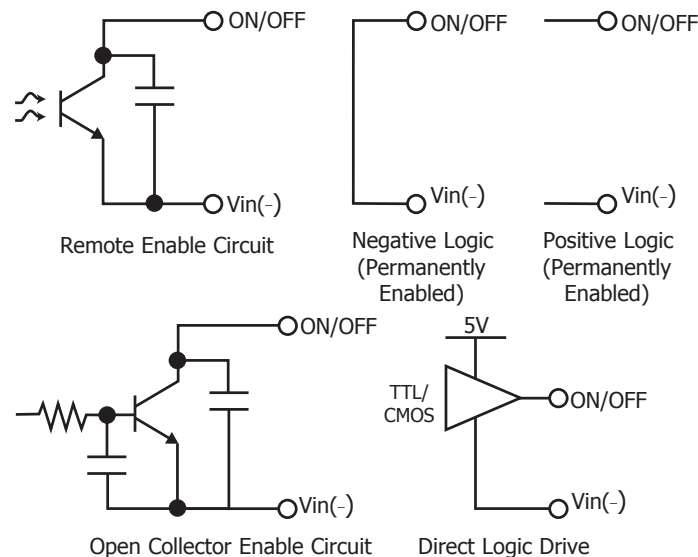

Figure A: Various Circuits for Driving the ON/OFF Pin.

CONTROL FEATURES

REMOTE ON/OFF (Pin 2): The ON/OFF input, Pin 2, permits the user to control when the converter is on or off. This input is referenced to the return terminal of the input bus, Vin(-).

In negative logic versions, the ON/OFF signal is active low (meaning that a low voltage turns the converter on). In positive logic versions, the ON/OFF input is active high (meaning that a high voltage turns the converter on). Figure A details possible circuits for driving the ON/OFF pin. See Ordering Information page for available enable logics.

REMOTE SENSE Pins 8(+) and 6(-): The SENSE(+) and SENSE(-) inputs correct for voltage drops along the conductors that connect the converter's output pins to the load.

Pin 8 should be connected to Vout(+) and Pin 6 should be connected to Vout(-) at the point on the board where regulation is desired. If these connections are not made, the converter will deliver an output voltage that is slightly higher than its specified value.

OUTPUT VOLTAGE TRIM (Pin 7): The TRIM input permits the user to adjust the output voltage across the sense leads up or down according to the trim range specifications. SynQor uses industry standard trim equations.

To decrease the output voltage, the user should connect a resistor between Pin 7 and Pin 6 (SENSE(-) input). For a desired decrease of the nominal output voltage, the value of the resistor should be:

$$R_{\text{trim-down}} = \left(\frac{100\%}{\Delta\%} \right) - 2 \text{ k}\Omega$$

where

$$\Delta\% = \left| \frac{V_{\text{nominal}} - V_{\text{desired}}}{V_{\text{nominal}}} \right| \times 100\%$$

To increase the output voltage, the user should connect a resistor between Pin 7 and Pin 8 (SENSE(+) input). For a desired increase of the nominal output voltage, the value of the resistor should be:

$$R_{\text{trim-up}} = \frac{\left(\frac{V_{\text{nominal}}}{1.225} - 2 \right) \times V_{\text{desired}} + V_{\text{nominal}}}{V_{\text{desired}} - V_{\text{nominal}}} \text{ k}\Omega$$

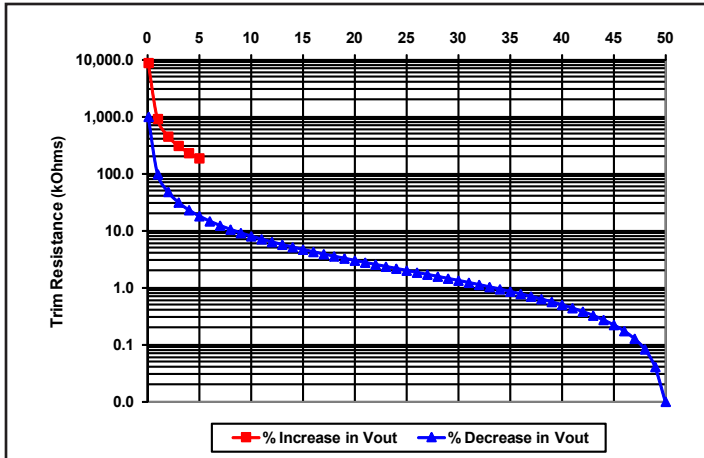

Figure B: Trim Graph.

The Trim Graph in Figure B shows the relationship between the trim resistor value and Rtrim-up and Rtrim-down, showing the total range the output voltage can be trimmed up or down.

Note: The TRIM feature does not affect the voltage at which the output over-voltage protection circuit is triggered. Trimming the output voltage too high may cause the over-voltage protection circuit to engage, particularly during transients.

It is not necessary for the user to add capacitance at the TRIM pin. The node is internally filtered to eliminate noise.

Total DC Variation of Vout: For the converter to meet its full specifications, the maximum variation of the DC value of Vout, due to both trimming and remote load voltage drops, should not be greater than that specified for the output voltage trim range.

Protection Features

Input Under-Voltage Lockout: The converter is designed to turn off when the input voltage is too low, helping to avoid an input system instability problem, which is described in more detail in the application note titled "Input System Instability" on www.SynQor.com. The lockout circuitry is a comparator with DC hysteresis. When the input voltage is rising, it must exceed the typical "Turn-On Voltage Threshold"* before the converter will turn on. Once the converter is on, the input voltage must fall below the typical "Turn-Off Voltage Threshold"* before the converter will turn off.

Output Current Limit: If the output current exceeds the "Output DC Current Limit Inception" point*, then a fast linear current limit controller will reduce the output voltage to maintain a constant output current. There is no minimum operating output voltage. The converter will run with low on-board power dissipation down to zero output voltage. A redundant circuit will shutdown the converter if the primary current limit fails.

Back-Drive Current Limit: If there is negative output current of a magnitude larger than the "Back-Drive Current Limit while Enabled" specification*, then a fast back-drive limit controller will increase the output voltage to maintain a constant output current. If this results in the output voltage exceeding the "Output Over-Voltage Protection" threshold*, then the unit will shut down. The full I-V output characteristics can be seen in Figure 19.

Output Over-Voltage Limit: If the voltage across the output pins exceeds the "Output Over-Voltage Protection" threshold*, the converter will immediately stop switching. This prevents damage to the load circuit due to 1) excessive series resistance in output current path from converter output pins to sense point, 2) a release of a short-circuit condition, or 3) a release of a current limit condition. Load capacitance determines exactly how high the output voltage will rise in response to these conditions.

Over-Temperature Shutdown: A temperature sensor on the converter senses the average temperature of the module. The thermal shutdown circuit is designed to turn the converter off when the temperature at the sensed location reaches the Over-Temperature Shutdown value. It will allow the converter to turn on again when the temperature of the sensed location falls by the amount of the Over-Temperature Shutdown Restart Hysteresis value.

Startup Inhibit Period: If any protection feature causes the converter to shut down, the converter will attempt to restart after 2ms (typical), the "Startup Inhibit Period".* On initial application of input voltage, with the ON/OFF pin set to enable the converter, the "Turn-On Time"* will increase by only 2ms.

*See specifications page

APPLICATION CONSIDERATIONS

Input System Instability: This condition can occur because any DC-DC converter appears incrementally as a negative resistance load. A detailed application note titled "Input System Instability" is available on www.SynQor.com which provides an understanding of why this instability arises, and shows the preferred solution for correcting it.

Application Circuits: A typical circuit diagram, Figure C below details the input filtering and voltage trimming.

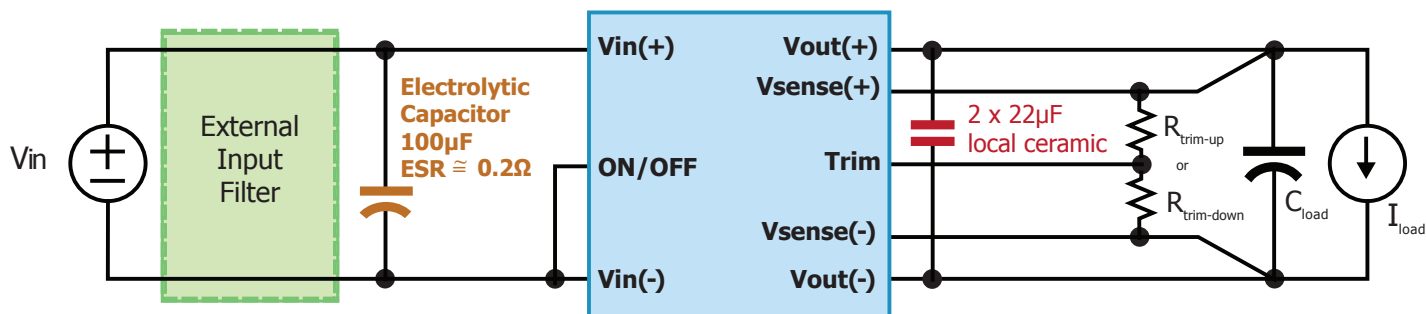

Figure C: Typical Application Circuit (negative logic unit, permanently enabled).

Input Filtering and External Input Capacitance: Figure D below shows the internal input filter components. This filter dramatically reduces input terminal ripple current, which otherwise could exceed the rating of an external electrolytic input capacitor. The recommended external input capacitance is specified in the Input Characteristics section of the Electrical Characteristics. More detailed information is available in the application note titled "EMI Characteristics", www.SynQor.com.

Output Filtering and External Output Capacitance: Figure D below shows the internal output filter components. This filter dramatically reduces output voltage ripple. However, some minimum external output capacitance is required, as specified in the Output Characteristics section on the Electrical Characteristics page. No damage will occur without this capacitor connected, but peak output voltage ripple will be much higher.

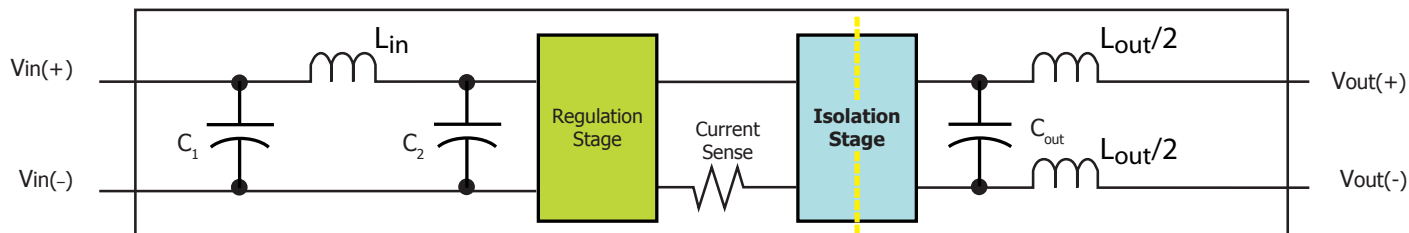

Figure D: Internal Input and Output Filter Diagram (component values listed in Electrical Characteristics section).



Ordering Information

Input: 35-75V
Output: 12V
Current: 30A
Package: Half-brick

Part Numbering System

The part numbering system for SynQor's dc-dc converters follows the format shown in the example below.

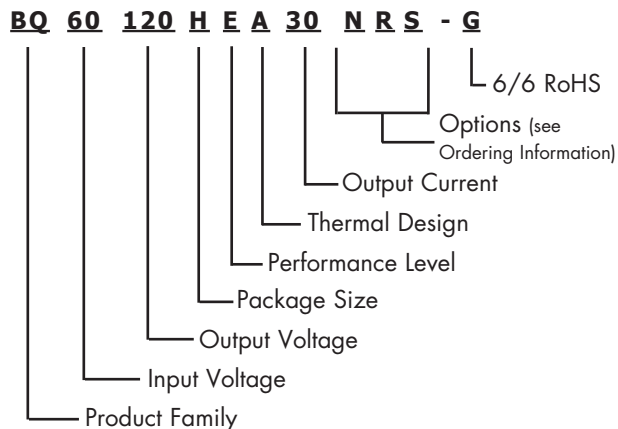

The first 12 characters comprise the base part number and the last 3 characters indicate available options. The "-G" suffix indicates 6/6 RoHS compliance.

Application Notes

A variety of application notes and technical white papers can be downloaded in pdf format from our [website](#).

RoHS Compliance: The EU led RoHS (Restriction of Hazardous Substances) Directive bans the use of Lead, Cadmium, Hexavalent Chromium, Mercury, Polybrominated Biphenyls (PBB), and Polybrominated Diphenyl Ether (PBDE) in Electrical and Electronic Equipment. This SynQor product is 6/6 RoHS compliant. For more information please refer to SynQor's RoHS addendum available at our [RoHS Compliance / Lead Free Initiative web page](#) or e-mail us at rohs@synqor.com.

Contact SynQor for further information and to order:

Phone: 978-849-0600 Toll Free: 888-567-9596 Fax: 978-849-0602

E-mail: power@synqor.com Web: www.synqor.com

Address: 155 Swanson Road, Boxborough, MA 01719 USA

WARRANTY

SynQor offers a three (3) year limited warranty. Complete warranty information is listed on our website or is available upon request from SynQor.

Ordering Information

The tables below show the valid model numbers and ordering options for converters in this product family. When ordering SynQor converters, please ensure that you use the complete 15 character part number consisting of the 12 character base part number and the additional characters for options. Add "-G" to the model number for 6/6 RoHS compliance.

Model Number	Input Voltage	Output Voltage	Max Output Current
BQ60120HEw25xyz-G	35-75V	12V	25A
BQ60120HEw30xyz-G	35-75V	12V	30A

The following options must be included in place of the **wxyz** spaces in the model numbers listed above.

Options Description: w x y z			
Thermal Design	Enable Logic	Pin Style	Feature Set
A - Open Frame B - Baseplated	N - Negative P - Positive	K - 0.110" N - 0.145" R - 0.180" Y - 0.250"	S - Standard

Not all combinations make valid part numbers, please contact SynQor for availability.

PATENTS

SynQor holds numerous U.S. patents, one or more of which apply to most of its power conversion products. Any that apply to the product(s) listed in this document are identified by markings on the product(s) or on internal components of the product(s) in accordance with U.S. patent laws. SynQor's patents include the following:

6,927,987 7,050,309 7,765,687
 7,787,261 8,149,597 8,644,027